

Printed in Italy
Date of first issue: 21.10.2020
Revision: 00-100122

***Informative note***

This manual cannot, even if partially, be reproduced, digitized and saved on data carriers of any kind and translated into other languages than Italian, except in the presence of explicit authorization from Balugani S.r.l., unique owner of this manual.

Despite the attention paid to the drafting of this technical manual, Balugani s.r.l. does not guarantee the accuracy of all information contained therein and shall not be held responsible for any errors or damages resulting therefrom.

In case of doubts regarding the understanding of the contents of this manual, we invite users to contact our technical department or our authorized service centers, (consult our web page **www.baluganisrl.it** to find useful contacts).

This manual is subject to periodic updates and improvements and Balugani s.r.l. reserves the right to make changes without prior notice.

This manual is an integral part of the automatic softener to which it refers, therefore it must be kept until the end of the softener's life.

**Chap.1**

- 1.1 PURPOSE OF USE OF BAV-BAVK-AVT-ELYS SOFTENERS
- 1.2 AVVERTENZE E PRESCRIZIONI DI SICUREZZA

Chap.2

- 2.1 WORKING CONDITIONS AND TECHNICAL DATA

Chap.3

- 3.1 GENERAL WARNINGS

Chap.4

- 4.1 DESCRIPTION OF SOFTENER
- 4.2 DESCRIPTION OF CONTROL VALVE

Chap.5

- 5.1 HOW THE BAV-BAVK-AVT-ELYS WATER SOFTENER WORKS

Chap.6

- 6.1 INSTALLATION - Warnings
- 6.2 INSTALLATION - Connections
- 6.3 INSTALLATION - First start-up
 - 6.3.1. INSTALLATION - First start-up of softeners equipped with a lack of salt alarm device
- 6.4 INSTALLATION - Electrical connection
- 6.5 INSTALLATION - Setting the menu language

Chap.7

- 7.1 HOW TO ACTIVATE THE REGENERATION OF THE RESINS MANUALLY

Chap.8

- 8.1 CONSULTING THE PROGRAMMING PARAMETERS (EXPERT USER)

Chap.9

- 9.1 SETTING THE TIME

Chap.10

- 10.1 ADJUSTMENT OF WATER HARDNESS (Hardness mixer)

Chap.11

- 11.1 MODIFICATION OF THE CYCLIC CAPACITY OF THE SOFTENER
- 11.2 MODIFICATION OF THE MINIMUM INTERVAL OF TIME BETWEEN REGENERATIONS



Chap.12

12.1 INTERRUPTION OF THE ELECTRIC POWER SUPPLY

Chap.13

13.1 MAINTENANCE

Chap.14

14.1 TROUBLESHOOTING

Chap.15

15.1 MARKING - SERIAL LABEL

Chap.16

16.1 DECLARATION OF CONFORMITY

Chap.17

17.1 DISPOSAL OF THE SOFTENER AT THE END OF LIFE

Chap.18

18.1 MAINTENANCE CARD

Chap.19

19.1 WARRANTY CONDITIONS AND CLAIMS

PURPOSE OF USE OF THE BAV-AVK-AVT-ELYS SOFTENERS

The BAV-BAVK-AVT automatic softeners are devices for the treatment of drinking water that are based on the principle of ion exchange softening, through which the calcium and magnesium ions (making up the hardness of the water) are replaced with ions of sodium, thus reducing the formation of limescale in water pipes, on taps, technological systems and household appliances (dishwashers, washing machines and coffee machines). All the materials used for the construction of softeners are suitable for contact with water intended for human consumption (DM174 / 2004). The BAV, BAVK, AVT and ELYS softeners can be equipped with a resin disinfection system (chlorine producer - optional, except AVT30 and ELYS30 which has it as standard), which is automatically activated by the control valve during the regeneration of the resins, which they will be subjected to bactericidal action by the generated chlorine.



1.2 WARNINGS AND SAFETY REQUIREMENTS

The softeners of our production are exclusively used in the treatment of drinking cold water only or meeting the drinking water criteria and must not be used for other purposes, tampered with or modified for any reason (ref. D.L.31 / 01 and subsequent amendments). Any other use is to be considered improper and potentially dangerous and / or harmful. The manufacturer cannot be held liable for any damage resulting from improper, erroneous and unreasonable use.

It is forbidden to feed the softener with liquids other than water and it is forbidden to introduce products other than hyper-pure salt in tablets specific for softening (EN973 TYPE "A") into the brine tank. The use of dirty or unsuitable salt could compromise the operation of the softener and void the warranty.

Before each use, check the integrity of the device in all its components. In the event that even partial breakage of the electrical power supply cable of the control valve is detected, it must be replaced with a product with the same characteristics, even better if it is "original" (contact the technical assistance center).

Before electrically connecting the softener, check that the power supply point is compatible with the characteristics shown on the softener power supply. The electrical safety of the device is ensured only in the presence of an efficient earthing system and fully compliant with the regulations in force. This manual provides instructions for information that do not enable the user to independently carry out installation and / or testing of live electrical equipment, which must be performed only by specialized and authorized personnel.

Do not wash the appliance with water jets and do not remove for any reason the protective casings of the softener control valve. For any repairs to the softener, you should only contact a service center indicated by Balugani S.r.l.

The automatic softener can be used by children under the age of 10 and by people with reduced physical, sensory skills, without experience or the necessary knowledge, as long as they are under surveillance and after they have received instructions on the safe use of the softener and an understanding of potential hazards. Children must not play with the device and cleaning and maintenance intended to be carried out by the user, must not be carried out by children without adult supervision.

2.1 TERMS OF SERVICE AND TECHNICAL DATA

THE AUTOMATIC WATER SOFTENER WORKS OPTIMALLY UNDER THE FOLLOWING CONDITIONS:

DATA		REQUIREMENTS
WATER	Water pressure	Minimum 1.8 Bar (180kPa) Maximum 5 Bar (500kPa)
	Water temperature (in service mode)	Minimum 5 ° C Maximum 35 ° C

DATA		REQUIREMENTS
ENVIRONMENT	Room temperature	Minimum 5 ° C - Maximum 50 ° C
	Relative humidity	<95% a 25°C
	Power Supply	100-230Vac – 12Vcc 50/60Hz 1,5A*

NOMINAL FLOW OF THE CONTROL VALVE: 2 mc / h



***Warning: always use only the original power supply provided by the manufacturer**

RECOMMENDATION in the presence of network pressure higher than 5 Bar, a pressure reducer must be installed upstream of the automatic softener in order to avoid damage to the softening system or malfunctions.

CYCLIC CAPACITY (with inlet water hardness equal to 40 ° F) and SALT CONSUMPTION per cycle.

BAV5 AVT5 BAVK5	BAV8 BAVK8	BAV10 BAVK10	BAV12/AVT9 BAVK12	AVT12 ELYS10	AVT15 ELYS15	AVT18 AVT15Big ELYS20	AVT30 ELYS30
450 Lt	650 Lt	850 Lt	1200 Lt	1500 Lt	1900 Lt	2200 Lt	3800 Lt
0,7 kg	1,0 kg	1,4 kg	1,8 kg	2,2 kg	2,9 kg	3,5 kg	5,7 kg

3.1 GENERAL WARNINGS

As soon as the softener is received, it will be advisable to ensure that the product is intact and free from damage caused during transport. In the event of damage detected, notify the courier as soon as possible, if still present at the time of verification, or the dealer.

If the packaging exceeds 20 kg in weight and does not exceed 40 kg, it must be handled by two operators with suitable handling equipment. Where required by current regulations, operators must be provided with suitable personal protective equipment.

Do not overturn the packaging or let it fall with force on the sides so as not to compromise the integrity of the content. The opening of the packaging will take place near the installation point and due to the presence of plastic bags, staples, polystyrene and adhesive tapes, make sure that these materials are not within reach of children, as they could become potential sources of danger. The softener must be removed from the top of the packaging.

Dispose of the packaging material in accordance with local regulations in force.

Before installing the softener, we recommend reading this manual in its entirety, as this allows you to obtain the essential information to install, program and use the automatic softener correctly and safely.

The automatic softener is delivered already programmed and does not require further programming by the user, other than the adjustment of the time (the procedure is explained in paragraph 9.1 of this manual).

In the softener, the electric motor, the electronic boards, the power supply and the display are not repairable and in the event of a fault, it will be necessary to replace them. It is always recommended to use original spare parts for ordinary and extraordinary maintenance.

In case of doubts about the installation and commissioning of the softener, after reading this manual, it is advisable to contact the retailer or the manufacturer.

DESCRIPTION OF SOFTENER BAV-BAVK-AVT-ELYS

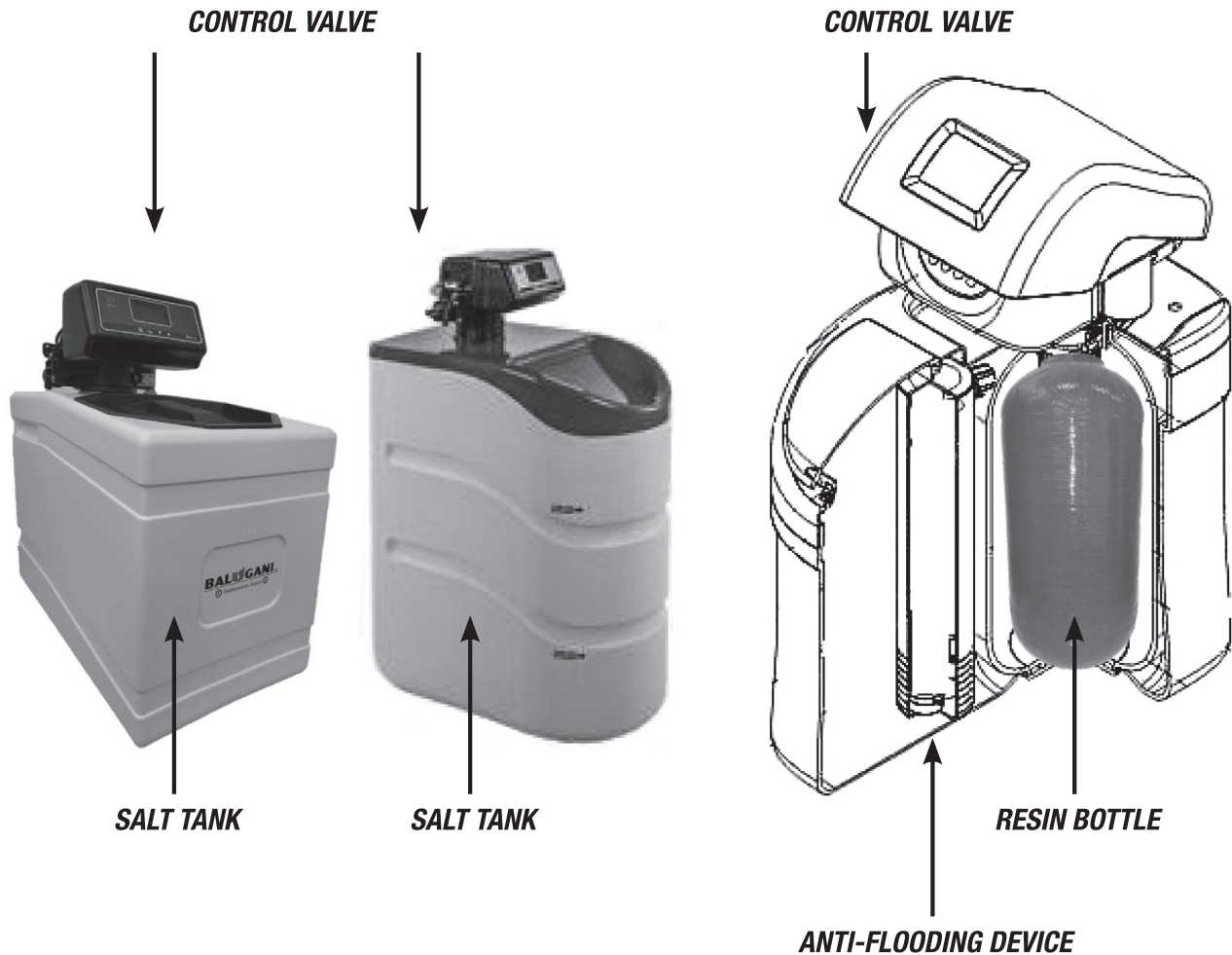

The control valve can be equipped with a **resin disinfection device** connected in series to the brine suction line, at the rear of the control valve (optional device, but mandatory in case of applications on ice makers or water dispensing machines for food uses with direct somministration).



4.2 DESCRIPTION OF THE CONTROL VALVE

Liter counter sensor (fig.1)

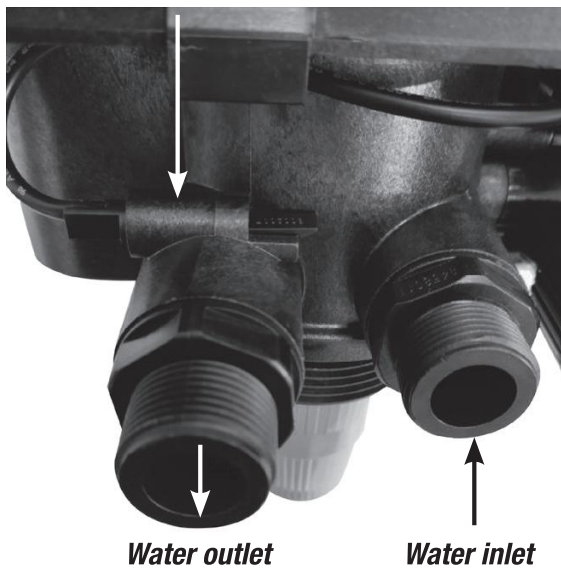

Brine suction line (Fig.2)

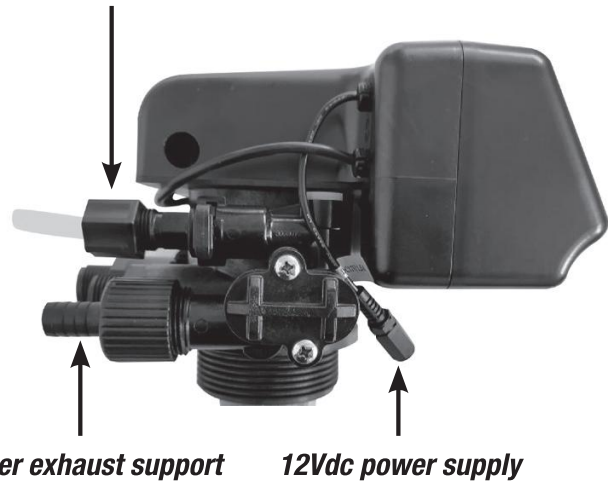

(Fig.3)

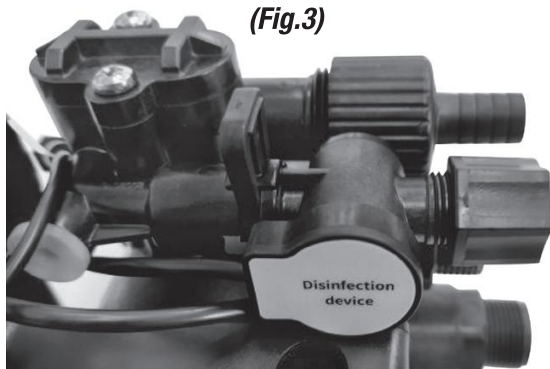

Configuration with resin disinfection



Display

(Fig.4)

Programming keyboard



(Fig.5)

230Vac - 12Vcc power supply

5.1 HOW THE BAV-BAVK-AVT-ELYS WATER SOFTENER WORKS

The BAV, BAVK and AVT automatic softeners work by exploiting the softening action of ion exchange resins with salt regeneration and are equipped with a statistical volumetric control valve, combined with the chronometric function. The regeneration of the resins therefore takes place in two alternative ways:

- 1- INTELLIGENT STATISTICAL VOLUMETRIC MODE: the water softener takes into account the daily water consumption and checks at the end of the day that for the next day there is sufficient softened water left to equal the water consumption of the previous day, so as to always guarantee softened water for the whole day. If the electronic controller of the softener determines that there is not enough residual water for the next day's needs, the softener will perform an early regeneration at 2.00AM (data programmed by the manufacturer), restoring the full capacity of softened water that can be supplied.
- 2- CHRONOMETRIC MODE: independently of the water consumption detected by the volumetric meter, the softener will regenerate the resins at regular intervals of 3 or 4 days (depending on the type of softener) starting from the last regeneration performed. This function makes the softener fully compatible with current regulations, which require rinsing of the resins at regular intervals to avoid bacterial proliferation in the water (especially in plants defined as intermittent). The anti-flooding floating valve is installed as standard in the softeners, which intervenes in the event of abnormal fillings inside the brine tank, caused by malfunctions of the control system, thus avoiding potential risks of flooding (the anti-flooding system does not intervene in the event broken pipes, fittings and other external factors).

The softeners can be equipped with an optional resin disinfection device that acts as a chlorine producer (fig. 3 paragraph 4.2), using the principle of electrolysis of the brine sucked in during the regeneration of the resins; the chlorine produced comes into contact with the softener resin column, ensuring an effective bactericidal action. During the regeneration phase, the softener will activate its internal bypass and mains water will be supplied until the resin regeneration is complete.

It is important to remember that for the regular and effective regeneration of the ion exchange resins of the softener, the level of the salt in tablets in the tank must never be below the "minimum salt level" indicated on the tank itself.

The softener is delivered programmed with cyclic capacity calculated with 40 French degrees of hardness on entry and zero French degrees of hardness on exit. The operating parameters are already set and the intervention of an operator is not required to program the softener (except to set the time, which however is already set by the manufacturer and is kept in the memory for about 15 days power failure, then it will have to be reprogrammed).

The hardness of the outgoing water can be brought to values above zero by acting on the mixing screw integrated in the control valve (see paragraph 10.1).

The cyclic capacity (liters of softened water that the softener can deliver between one regeneration and the next) can also be changed (see paragraph 11.1).

6.1 INSTALLATION - Warnings



The water supplying the softener must be exclusively drinkable and with characteristics that comply with the limits set out in Decree Law 31/2001, relating to the quality of water intended for human consumption. Do not connect the softener in the presence of water pressure values below 1.8 Bar and above 5 Bar.

Always use only the original power supply supplied with the softener and in case of failure, replace it with an original one supplied by the manufacturer or an authorized technical assistance center.

The installation must be carried out safely by qualified personnel authorized to issue a suitable declaration of conformity pursuant to Ministerial Decree 37 of 22/01/2008, using only suitable materials.

The softener must be installed in a closed and ventilated environment, protected from bad weather, frost and direct sunlight. In the immediate proximity there must be an adequate power supply point (connected to an electrical system compliant with national regulations), a mains water supply manifold and a connection point for waste water (the drain must not be connected directly to a collector or immersed in wells with stagnant water, this to avoid the risk of siphoning with the return of polluted water). The distance between the softener and the discharge point must be less than 4 meters and with a height difference of less than 2 meters. The presence of folds and bottlenecks along the discharge line is strongly discouraged. The drain must be siphoned and in no case must the backflow of other drains to the softener be allowed. It is recommended to install a safety filter upstream of the softener to protect the internal movement parts of the control valve.

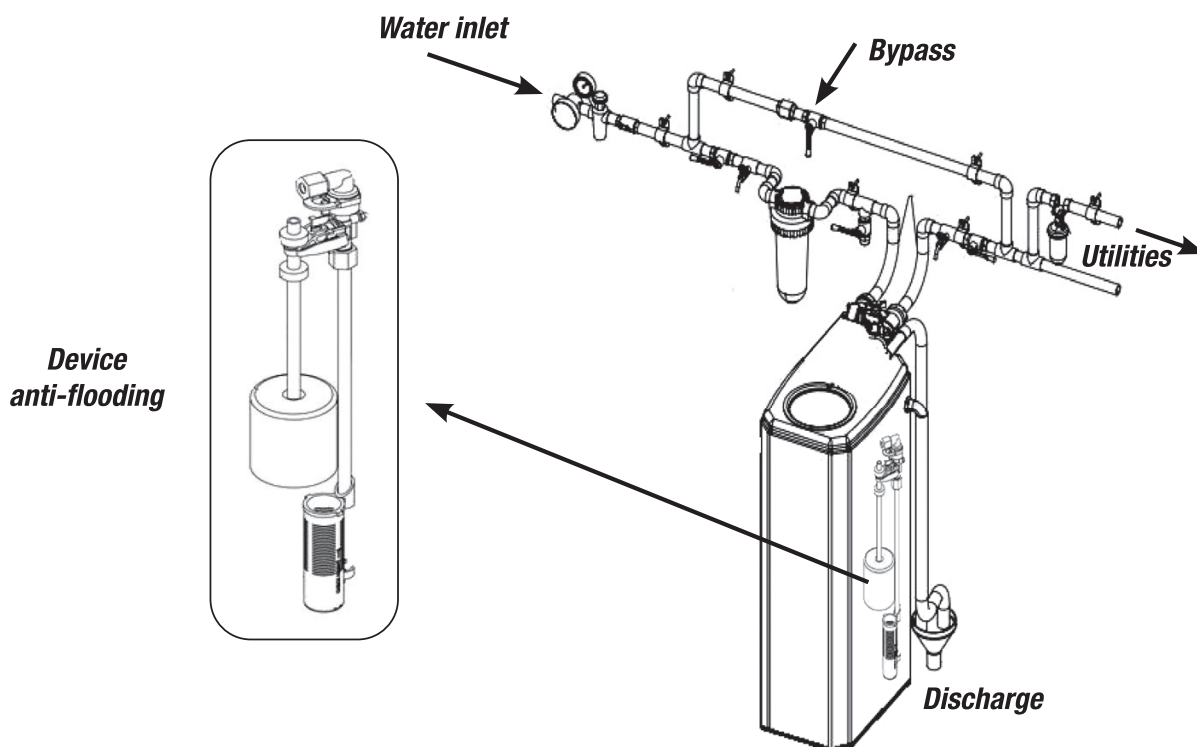

6.2 INSTALLATION - connections



Do not power the softener electrically before the end of the hydraulic connections.

The drain hose (supplied) must be fixed on one side to the drain hose connector of the water softener valve (FIG. 3) and STABILIZED with a plastic clamp; on the other side connected with drain to avoid possible water leaks and in such a way as to eliminate potential risks of backflow of waste water, with consequent contamination of drinking water. Connect the mains water pipe to the softener inlet (FIG.2), then connect the softener water outlet to the user to be served (FIG.1). For the hydraulic connection, use only suitable materials and components.

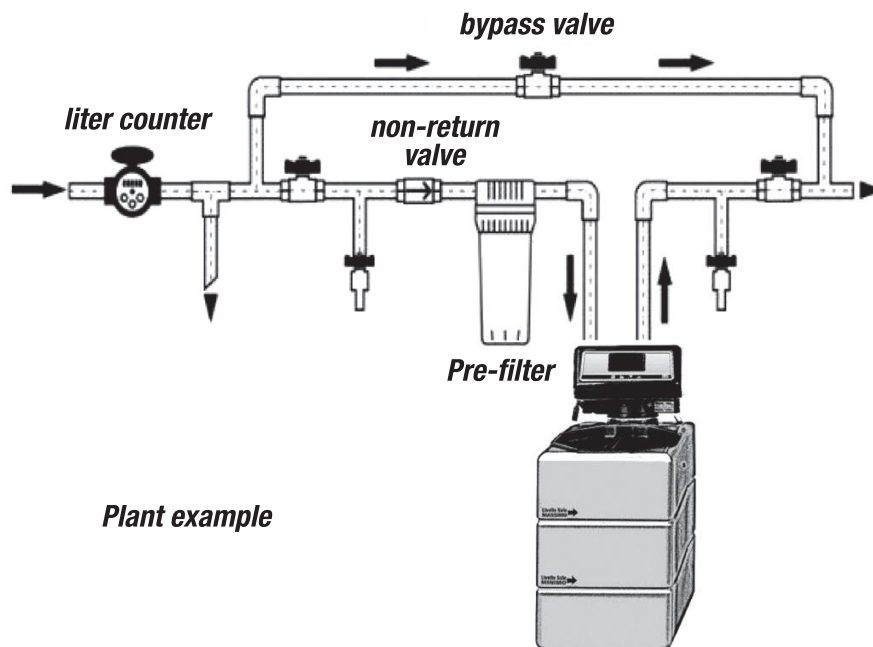
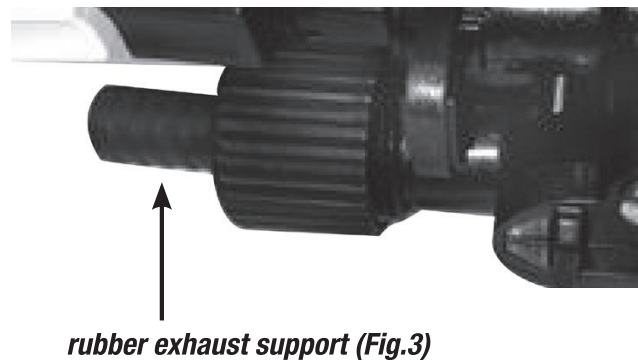
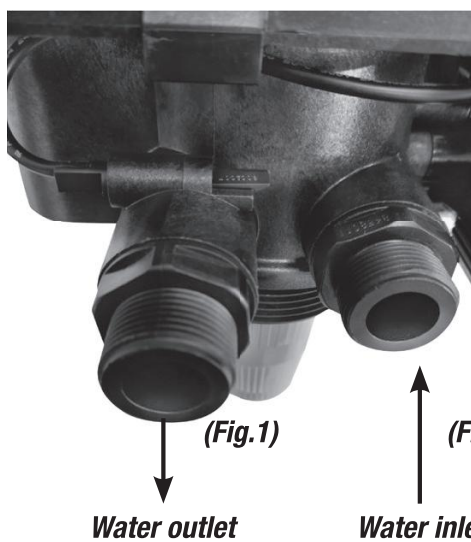

6.3 INSTALLATION - First start-up

Once the hydraulic connections have been completed, the system must be started up for the first time.

Pour water into the brine tank: 2.5 liters for BAV5 / AVT5 / BAVK5 softeners, 4 liters for BAV8 / BAVK8 / AVT9 softeners, 5 liters for BAV10 / BAVK10 / AVT9 softeners, 6 liters for BAV12 / BAVK12 / AVT12 / ELYS10 softeners, 8 liters for softeners AVT12 / 15 / ELYS15 and 10 Liters for AVT15BIG / 18/30 / ELYS20/30 softeners, **(operation to be carried out only for the first installation, subsequently the softener will autonomously restore the correct water levels in the tank).**

Pour the salt into the tank (of the EN973 hyperpure type for softeners), **not exceeding the maximum level indicated.**

Slowly open the mains water supply tap. Open a tap or other utility downstream of the softener and let the water run for about 2/3 minutes, the time necessary to free the pipes from any presence of air and to rinse the softener resins. Close downstream users if not necessary for other operations.

6.3 .1 INSTALLATION - First start-up for softeners equipped with a lack of salt alarm device

Softeners can be equipped with an optional salt lack alarm device.

This device detects the lack of salt inside the brine tank and generates an audible (buzzer) and visual warning (message on the softener display).

The alarm cannot be reset with a button, but only and exclusively by restoring the right level of salt inside the brine tank.

The first start-up process for these softeners is as follows:

- 1- Pour water into the vat up to the MINIMUM SALT LEVEL (indicated on the vat with appropriate writing).**
- 2- Fill the salt vat up to the MAXIMUM SALT LEVEL (indicated on the vat with the appropriate writing) (operations to be carried out only for the first installation, subsequently the softener will independently take care of restoring the right levels of water in the vat).**



Do not fill the salt vat beyond the maximum level indicated.

6.4 INSTALLATION - electrical connection

Once the hydraulic connections and the operations for the first start-up of the system have been completed, you can proceed with the power supply of the softener.



Always dry the wet parts of the softener before connecting the power supply.

The power supply supplied must be connected to a wall socket that is always live (230Vac-50 / 60Hz), compliant with current regulations and connected to a system designed and built by specialized and qualified professionals, provided with grounding and protected by suitable differential electric switch.

The softener will then be powered in low voltage (12Vdc) through a suitable connection plug.



It is forbidden to use multiple plugs, adapters and extensions outside the standard. The use of extensions and multiple sockets is allowed only if they have the quality certification mark and technical characteristics fully compatible with the system to which they will be connected.

Use only the power supply supplied, or a power supply with the same characteristics.

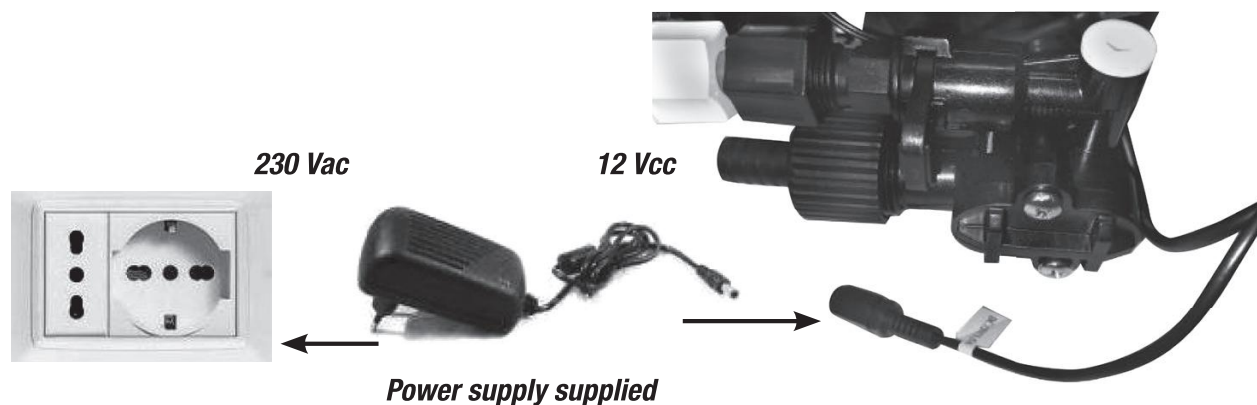

The softener is operational and from now on, each operation will be performed independently by the electronic control system.





Warning: The softener is not a device that can be used in environments with an explosive atmosphere or with a high risk of fire.

6.5 INSTALLATION - Setting the menu language

The softener is equipped with a multilingual display.

To select a language other than the one set (the standard is Italian), proceed as follows:

1. Disconnect the power supply to the control valve.
2. Connect the power supply to the valve again and press immediately, simultaneously and for about 5 seconds the buttons  
3. Release the two buttons as soon as the language menu appears.
4. With the “ARROW” buttons it is possible to go to the required language, then confirm the choice with the button 

The display will now show the menu in the selected language.

7.1 How to activate the regeneration of the resins manually. (forced regeneration)

The softener is designed to perform the regeneration of the resins completely autonomously and automatically. However, in some cases it may be necessary to force a regeneration (for example, in the in case of maintenance and / or cleaning of the softener).

It is therefore possible to manually start the regeneration of the resins without having to wait for the softener activates it automatically, according to the parameters set.

Check that the salt tablets are present in the brine tank and proceed as follows:

If necessary, unlock the keyboard by pressing SIMULTANEOUSLY   for about 5 seconds.

In service position, press the button 

The regeneration of the resins will start immediately and will be completed automatically and without further intervention by an operator.

It is also possible to skip one or more phases of the regeneration, passing to the next, by pressing the button  (Operation intended for expert personnel).



Warning: skipping the resin rinsing phase will result in inevitably, for an unspecified number of minutes, the entry of salt water in the circuit of utilities connected downstream of the softener.

8.1 Consultation of programming parameters (expert users)

As previously reported, the programming data of the automatic softener control valve have already been entered by the manufacturer before being sold to the customer.



It is advisable **not to modify the factory data** as these are optimal for most possible installations. The modification of the programming parameters by inexperienced people could cause the softener to **malfunction**.

However, it is possible to consult the values of the programming parameters by following the procedure below:

If the keyboard is locked, press simultaneously for about 5 seconds.

To access the parameters, press and scroll the menu using the arrow keys.

The key is used to take a step back within the menu item.

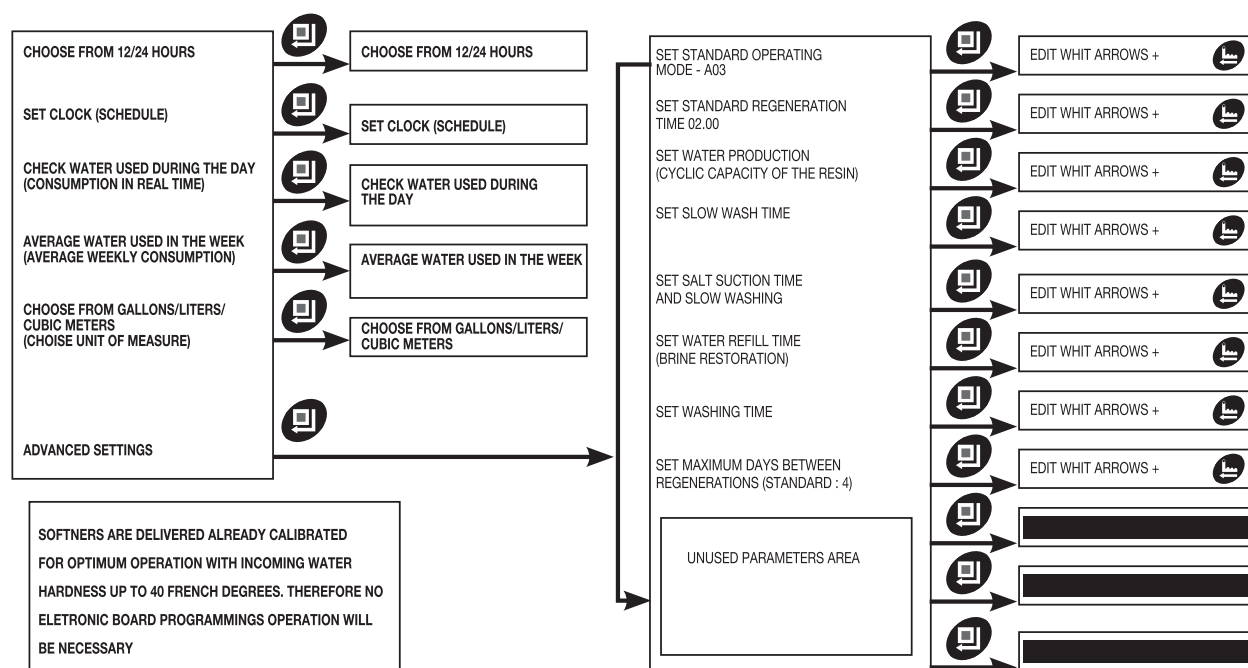

After 60 seconds of inactivity, the keyboard will be locked and a small padlock symbol will appear at the top left of the display.

9.1 TIME SETTING

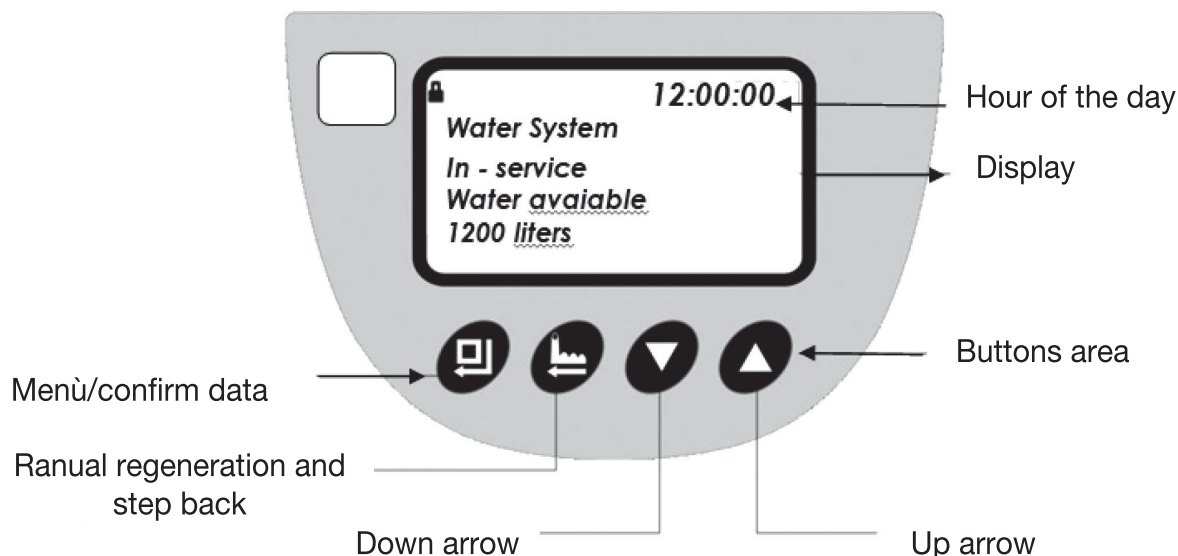

If the time is incorrect when the display is switched on, the exact time must be set, proceeding as follows:

If the padlock symbol appears at the top on the left it means that the keyboard is locked and to unlock it will have to press the “arrow up / down” keys **simultaneously** for about 5 seconds.

Once the padlock symbol has disappeared, press MENU \ CONFIRM DATA  (“**choose 12 \ 24 hours**”).

With the DOWN ARROW key go to the item “**set clock**” and confirm with the key MENU \ CONFIRM DATA. 

Adjust the hours and minutes using the “UP \ DOWN arrow” keys and confirm with the key 

To return to the service screen, press the STEP BACK button.  Until the appearance of the written “system in operation”.

(ATTENTION: do not press the button  further after the message “system in operation “, otherwise the forced regeneration of the resins will be activated - paragraph 7.1).

After 60 seconds the padlock symbol will reappear at the top on the left and the keyboard will be back in safety lock.

10.1 ADJUSTMENT OF WATER HARDNESS (Hardness mixer)



The control valve of the BAV / BAVK / AVT / ELYS softener is equipped with an outlet water hardness adjustment system.

By acting with a screwdriver on the adjustment screw shown in the image to the side, it is possible to mix the softened water (which comes out at zero French degrees of hardness from the softener), with the mains water, to obtain water for the user with hardness greater than zero degrees.

With the screw fully tightened, the softener will deliver water at zero French degrees.

By loosening (unscrewing) the screw, you will get a gradual increase in the hardness of the outgoing water.

Use a suitable hardness measurement kit to check the results obtained.



Avoid loosening the mixing screw too much (**no more than 5 turns**) to avoid expulsion with the risk of water leaking.

Do not over tighten the screw to avoid breaking the threaded plastic part in which it is housed.

The softener is supplied with the screw adjusted for the outlet of water at zero French degrees of hardness.

Adjusting the hardness of the water leaving the softener must be assisted by a suitable hardness measurement kit, easily available on the market, also at Balugani service centers (send requests for information to: info@baluganisrl.it).

11.1 CHANGE IN THE CYCLIC CAPACITY OF THE SOFTENER

The BAV / BAVK / AVT / ELYS softeners are programmed with cyclic capacity calculated with a hypothetical hardness of incoming water equal to 40 French degrees (the cyclic capacity is the maximum number of liters of water softened that the softener is able to deliver after each regeneration of the resins to a certain hardness).

In the presence of water hardness higher than 40 degrees or definitely lower than 40 degrees, it can be it is advisable to set the new cyclic capacity according to the hardness of the water to be softened, obtaining the ideal performance of the softener.

To modify the cyclic capacity parameter, operate from the service position as follows:

Press the menu / Confirm data key 

Press the “Down arrow”  key 5 times, until you reach the “Advanced setting” item.

Press the menu / Confirm data key 

Press the “Down arrow”  key twice, until you reach the item “set water production in cycle”.

Press the menu / Confirm data key 

Modify the set value with the arrow keys, replacing it with the value obtained from the following formula: (LITERS OF SOFTENER RESIN X 5000) / INLET WATER HARDNESS.

Confirm the data entered with the key  and return to the service screen by pressing the key  repeatedly until the message “System in operation” appears.

(ATTENTION: do not press the button  further after the message “system in operation“, otherwise the forced regeneration of the resins will be activated - paragraph 7.1).





Periodically measure the hardness value of the water to be treated for check that it has not changed. In this case, repeat the above operation reported to optimize the performance of the softener. Use a suitable water hardness measurement kit.

11.2 MODIFICATION OF THE MINIMUM INTERVAL OF TIME BETWEEN REGENERATIONS (forced regeneration within the fourth day according to the regulations)

In the event of low water consumption, such as not to activate at least one regeneration every 4 days, the softener will automatically activate a regeneration at the end of this day (deadline set by the regulations in force). This time interval can still be modified by the user, by operating as follows:

From the service position, press the key  and press the **down arrow** key 5 times, up to “**advanced setting**” item.

Press the key  and press the **down arrow** key 7 times, until the item “maximum days between regenerations”.

Press the key  and with **the arrow keys** select the new value to be set (we recommend not exceed 7 days), then press the button .

To return to the service screen, press the key  until the “System in operation” screen.

(ATTENTION: do not press the button  further after the message “system in operation”, otherwise the forced regeneration of the resins will be activated - paragraph 7.1).

This type of regeneration takes place only if the volumetric meter does not detect consumption of water such as to require the activation of the regeneration of the resins at time intervals of less than the one set in the “maximum days between regenerations” parameter.

12.1 ELECTRICAL POWER FAILURE

The electronic control board of the softener is equipped with a buffer battery that allows the time setting to be maintained for up to 15 days.

The programming data will be permanently kept in an EPROM memory and therefore it will not be necessary to reprogram them in the event of a power failure.

No power supply	
In service	The display will be off and no regeneration will be possible, not even the forced one. The liter counter will not be in operation. The set time will instead be kept updated for about 15 days, thanks to an autonomous power supply system.
In the regeneration phase	In the event of a power failure during the resins regeneration, the display will be off, the softener will remain in the condition it was in at the time of the power failure and when the power was restored, regeneration will resume exactly from the point where it had stopped, without any risk that the work phase could be unsuccessful or compromised. To protect the softener, in the event of a shutdown during the brine restoration phase, the anti-flooding device will intervene (if necessary). Once regeneration is complete, the softener will be in the service position and will not require any intervention by the user.

In the event of a power failure lasting more than 4 days, it will be necessary to activate a forced regeneration to rinse the resins (see paragraph 7.1).

13.1 MAINTENANCE



Attention: the automatic softener you purchased requires regular and appropriate periodic maintenance to maintain the minimum requirements necessary for optimal operation and to comply with the regulations in force on hygiene in water treatment (Ministerial Decree 25/2012).

External cleaning

Use only a cloth / sponge and non-abrasive detergents, without using pressure water jets that could damage the electrical and mechanical parts of the control device.

Internal cleaning of the brine vat

At least twice a year, the internal cleaning of the salt vat must be carried out to eliminate sediments and foams that may periodically form due to salt deposits. The vat must be emptied and cleaned with water and a few drops of sodium hypochlorite (**maximum 2% solution**) to obtain a bactericidal and fungicidal action. Rinse with **plenty** of drinking water after cleaning.

Sanitizing the resin bed

Sanitizing the resins contained in the softener bottle must be performed at least twice a year. For this operation it will be advisable to clean the salt vat beforehand (see above), then pour about 3-4 liters of water into the salt vat, add sodium hypochlorite (**solution not exceeding 2%**), add salt in pads not exceeding the maximum level shown on the salt vat, **wait about 15 minutes and start the manual regeneration of the resins** (see dedicated paragraph). The softener will then be sanitized and with the resins regenerated and immediately available to perform the softening action.

Checking the efficiency of the resins

At least three times a year it would be advisable to test the performance of the resins, using a suitable **hardness test kit** (available from the manufacturer or a service center). Perform the test immediately after the regeneration of the resins (making sure the presence of salt tablets in the vat before regeneration) and if the water is hard, it means that the resins have lost their ability to regenerate and must therefore be replaced. The average life of the resin is approximately 5 years if used correctly.

Checking the salt level

At least twice a month it would be advisable to check the presence of salt in the brine tank of the softener and if necessary, add salt up to the level indicated on the tank itself. **Always use only hyper-pure salt in tablets specifically for softening.**



Warning: All maintenance operations must be carried out safely, with the device disconnected from the power supply and reactivated only when necessary. Any other operation not listed in this manual must be performed exclusively by technical personnel with the necessary training, specific knowledge of the product, electrical and hydraulic safety standards and the use of suitable personal protective equipment.

14.1 TROUBLESHOOTING

EVENT \ FAILURE	POSSIBLE CAUSES	POSSIBLE SOLUTIONS
The control valve does not regenerate automatically	1 Power supply switched off 2 Phase motor defective	1 turn on the power supply 2 replace the faulty motor
The control valve regenerates the resins at the wrong time	Incorrect setting of the current time	Program the time correctly
Failure to draw brine during regeneration	1 insufficient water supply pressure (less than 1.8 Bar) 2 clogged drain circuit 3 no mains water 4 valve injector clogged	1 ensure at least 1.8 Bar of water pressure. 2 remove the obstruction of the circuit 3 check the water mains connections 4 contact the service center
The brine tank gets too full	1 anomalous filling speed 2 aspiration of air into the tube that connects the valve to the vat 3 leakage between cylinder and valve or porosity of the cylinder	1 bring the water inlet pressure between 1.8 and 5 Bar 2 check the integrity of the fittings and the connection pipe 3 check for leaks between the cylinder and valve or water leaks from the cylinder
Presence of unsoftened water after regeneration of the resins	1 lack of salt in the brine tank 2 open bypass on the circuit 3 exhausted resins (end of life)	1 restore the salt level and reactivate regeneration manually 2 close the bypass 3 replace the softener resins
Hard water coming out during the day despite regular daily regeneration	Water softener undersized. Probable water consumption higher than the cyclic capacity of the softener	Connect a water softener with cyclic capacity adequate to daily consumption to the users.
Presence of salt water leaving at the end of regeneration	1 clogged drain circuit 2 no mains water or irregular mains pressure	1 remove obstruction 2 check the water mains connection and check the pressure values
<p>Avoid disassembling control valve components if you do not know exactly how to work. In case of doubts about how to intervene, always contact the manufacturer or a service center. If possible, contact the service center while staying close to the softener, so that checks, often resolving, can be carried out directly in the field with the telephone guide of a technician.</p>		

Anomalies found not present in the table above:

.....

.....

.....

15.1 Marking - Serial number label

A label similar to the one shown below is applied to each automatic softener we produce.

This label shows the following data:

- Manufacturer's data
- Product code
- Main technical data
- Badge number
- Production lot
- CE conformity



Any other data not explicitly reported on the label is however reported in this instruction manual.

The information on the label uniquely identifies the product and must always be communicated to the manufacturer, the retailer or the service center, in the event that technical assistance is required, including telephone assistance, or if spare parts are required.

Attention: the removal or tampering of the product identification label is prohibited.

15.2 Manufacturer's data

BALUGANI S.r.l.

Via VALLALBANA, 5 - 44123 Ferrara (FE)

Tel. +39 0532 427485

info@baluganisrl.it

www.baluganisrl.it

16.1 Declaration of Conformity

Made in Italy by:



Declaration of Conformity

The automatic ion exchange softeners produced by Balugani S.r.l. are built with quality components and raw materials suitable for contact with water for potable use, as required by Ministerial Decree 174/2004 and certified by analyzes conducted on behalf of Balugani S.r.l. by laboratories accredited by the ACCREDIA accreditation body and comply with the following regulations:

D.M. 174/2004: *Regulation concerning materials and objects that can be used in fixed systems for the collection, treatment, adduction and distribution of water intended for human consumption (Official Gazette July 17, 2004 No. 166)*

D.M. 07/02/2012 no. 25: *Technical provisions concerning equipment for the treatment of water intended for human consumption (Ministerial Decree 443/90 - Domestic equipment for the treatment of drinking water)*

Low Voltage Directive: 2014/35 / UE (update 2006/95 / EC)

Electromagnetic Compatibility Directive: EN 55014-1 (2006-12) + A1 (2009) + A2 (2011) EN 55014-2 (2015-04) - 2014/30 / UE

Machinery Directive: 2006/42 / EC

CEI EN 60335-1 : 2012: *Safety of household and similar electrical appliances*

Legislative Decree n.31 February 2, 2001: *Implementation of Directive 98/83 / EC relating to the quality of water intended for human consumption*

EN 50581:2012: *Restriction of Hazardous Substances (RoHS) - 2011/65/EU*

Reg. (CE) 1935: 2004: *compliance for food contact MOCA (Test report 20-06283-02)*

Ferrara, 21.10.2020

BALUGANI S.R.L.
IL PRESIDENTE D.E.L.C.A.
[Signature]



Products marked with the crossed-out bin symbol, present on the label applied to the device itself, on the packaging or on its instructions, indicate the compliance of this product with the European Directive 2012/19 / EU relating to the management of waste electrical and electronic equipment (WEEE or WEEE). Dispose of this softener separately from normal waste and scrupulously comply with the regulations in force in the country where this product will be disposed of (mandatory disposal at suitable WEEE waste collection centers).

17.1 Disposal of the softener at the end of its life

The automatic softener to which this manual refers is made of plastic, metal and electronic boards.

Proper disposal of these materials constitutes a preventive action against potential environmental damage and damage to human health.



This symbol, placed on electrical-electronic equipment, indicates that the equipment must not be disposed of in an undifferentiated way, but in accordance with the provisions of Directive 2012/19 / EU, also known as WEEE.

For the correct disposal of this appliance, it is advisable to refer to the legislation in force in the place where this appliance will be disposed of. More information will be available at the local waste collection body.

The provisions of the legislation are summarized:

- 1) There is an obligation to dispose of WEEE products not as municipal waste, but by carrying out separate collection.
- 2) The device in question may contain substances considered harmful or dangerous and their improper use or incorrect disposal could have a negative impact on the environment and human health.
- 3) To dispose of the WEEE product, only the collection systems provided for by current regulations should be used.
- 4) Illegal or in any case incorrect disposal of WEEE waste may be punished with administrative sanctions, as provided for by current regulations on waste disposal.
- 5) Where possible, separate the plastic, metal and electrical / electronic parts.



In any case, it is not allowed to throw the softener construction material in the unsorted collection.

WARRANTY CONDITIONS and CLAIMS

The guarantee will be valid for a period of 12 months starting from the date shown on the tax document proving the purchase.

During the warranty period, the manufacturer undertakes to remove any flaws or defects that jeopardize the correct functioning of the softener and undertakes to provide free spare parts of the parts deemed defective due to manufacturing defects, provided that the softener has been installed and used correctly, without having been tampered with by the user without prior authorization from the manufacturer.

It is not allowed to send the product to the manufacturer or to the service center without explicit written authorization, which in any case does not exempt the customer from bearing the transport costs for returning the product. If the warranty coverage is recognized, the manufacturer undertakes to repair or replace the defective product and to return it without increasing costs to the customer.

There is no guarantee in cases of:

- **Defects due to negligence, improper use or incorrect maintenance of the product, as well as incorrect installation.**
- **Worn parts whose defects are consequent to wear of the product even in normal conditions of use.**
- **Damage resulting from use that does not comply with specific regulations in force in the place where the product is installed.**
- **Damages or malfunctions resulting from maintenance, technical interventions on the product or modifications carried out by unauthorized personnel.**
- **Failures caused by natural disasters or accidental causes.**

Compensation requests for damages resulting from ascertained defects in the automatic softener must be communicated in writing to Balugani S.r.l. specifying in detail the serial number and production batch of the product, the type of damage caused, documentation proving the purchase of the product and the detected defects. Pursuant to the Consumer Code, with reference to the European Directive 85 \ 374 \ CE and subsequent amendments, the burden of proof of the product defect, of the damage caused and of the direct causal relationship between damage and defect, rests with those who request indemnity. For this reason, the company Balugani S.r.l. reserves the right to take into consideration only the requests received accompanied by suitable technical expertise.

For any dispute, unless otherwise agreed between the parties, the Court of Ferrara will be competent.

